

MUSE MOPA

USER MANUAL



Full Spectrum
L A S E R

Table of Contents

The MOPA Fiber Galvo by Full Spectrum Laser	2
Symbols and Definition	3
Section I. Safety	4
Setup Precautions	4
Safety During Operations	5
Fire Safety	6
Electrical Safety	7
Section II. Connectivity	8
Internet Connection	8
Connect to Software	9
Section III. Touchscreen Interface	10
Focusing	12
Section IV. Operations & Using Your Galvo	14
General Functions	14
Project Workflow	15
Section V. RetinaEngrave V3	18
Starting RE3	18
Camera	20
3D Camera Calibration	20
Section VI. Lens Calibration	21
Lens Replacement	21
Recalibration Process	22
Mark Adjustment	23
Preview Adjustment	24
Shutter Replacement	24
Troubleshooting & Applications	26
Troubleshooting	26
Applications	27
Samples	28
Free Projects & Extra Help	29
Warranty	30
Customer Support	31
Upgrades	32
Join the Full Spectrum Laser Community	33

The MOPA Fiber Galvo By Full Spectrum Laser

Thank you for purchasing your new Muse Fiber Galvo with Full Spectrum Laser. Our high quality products will provide years of service simply by following proper usage and upkeep.

This user manual will guide you through the safety guidelines and operation of your machine. We recommend that you familiarize yourself with this manual before using your laser engraver. Remember to be safe and have fun!

For more information, please visit www.fslaser.com

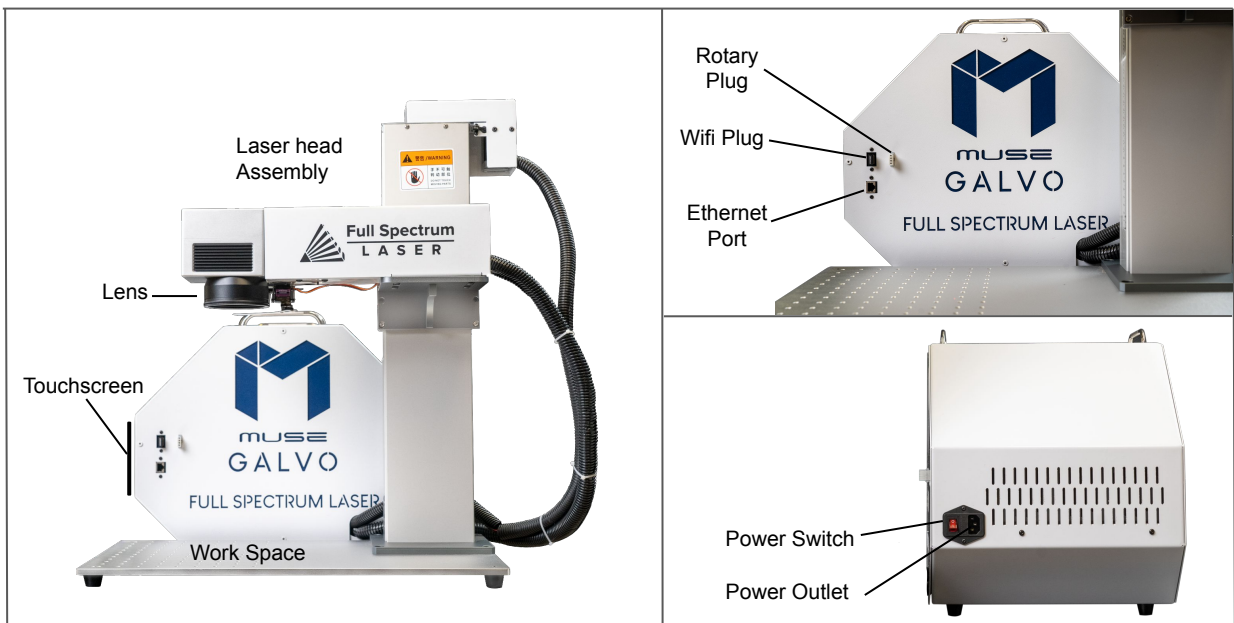

Compliance Statement: The Full Spectrum Laser MOPA Fiber Galvo Laser System is a Class 3B laser product, as defined in International Standard IEC 608251. The Full Spectrum MOPA complies with 21 CFR 1040.10 and 1040.11, the Federal Performance Standards for Light Emitting Products, except for deviations pursuant to Laser Notice No. 50, dated July 16, 2001. The Center for Devices and Radiological Health of the US FDA issued Laser Notice No. 50 to permit manufacturers to classify and manufacture their products in accordance with the International Standard. 21 CFR 1040 and IEC 608251 require that certification, identification, and warning labels be placed on laser products.

Symbols and Definitions

Red icons indicate dangerous situations that could result in serious injury or death.



This symbol indicates a hazardous situation.



This symbol indicates the risk of fire.

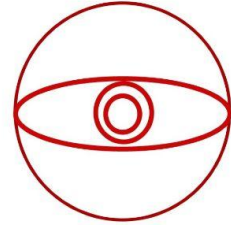

This symbol indicates the risk of potential eye injury.



This symbol indicates a respiratory hazard.

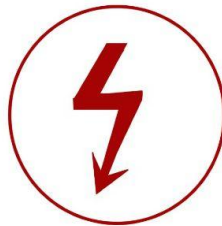

This symbol indicates an electrical hazard.



This symbol indicates the risk of getting cut by a sharp object.



This symbol warns of fragile parts.



This symbol calls attention to important details.

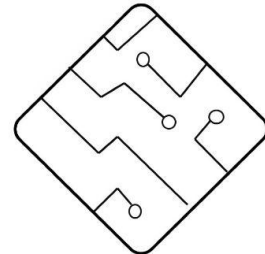

This symbol warns of network or software issues.

⚠ DANGER

Danger: Indicate[s] a hazardous situation which, if not avoided, will result in death or serious injury.

⚠ WARNING

Warning: Indicate[s] a hazardous situation which, if not avoided, could result in death or serious injury.

⚠ CAUTION

Caution: Indicate[s] a hazardous situation which, if not avoided, could result in minor or moderate injury.

Section I. Safety

Setup Precautions

Follow all safety protocols and procedures before operating any machinery. It is the responsibility of the operator to ensure all safety precautions are correctly followed, and that the machine is properly assembled and in working order.



WARNING!

- **Always inspect the laser cutter for damage or breakage before each use. Do not operate machinery that is damaged or defective in any way.**
- **Always have a clean, level, and open work space to unbox and place your laser cutter.**
- **Never modify, disassemble, or in any way alter the construction of the laser and never start up a system that has been modified or disassembled.**
- **Never leave the laser system unattended during operation.**
- **Do not disassemble the machine or remove any of its protective covers.**
- **Always have on hand a first-aid kit designed for the initial treatment of burns and smoke inhalation.** Be sure to store this kit in an area that is outside risk areas.
- **Never operate the machine with any of the panels removed.** Be aware that removal of any portion of the cabinet will expose the laser system and greatly increase the risk of injury and/or fire. Personal injury and fire risks are especially pronounced if the machine is operated with the bottom panel removed.



WARNING

- **Never place hands or fingers into moving parts such as cooling fans.**

Safety During Operation

The output of the fiber engraving laser is fully contained in a Class 3 enclosure during normal operation. However, the output beam is accessible to the operator during normal operation, giving the total system an overall rating of Class 3B. Class 3 lasers have minimal safety concerns when used properly and handled with care. The laser system is designated as Class 3B due to the fact that safety glasses must be used when observing the laser engraving process.

Follow these Safety Guidelines at all times:



- **Never engrave or cut any unknown material.** The vaporization/melting of many materials, including but not limited to PVC and polycarbonates, can give off hazardous fumes. Please refer to the MSDS sheet from the material manufacturer to determine the response of any work material to extreme heat (burning/fire hazard).
- **Never operate the machine in an area without a proper ventilation.** Most materials produce an irritating smoke when engraved. Some materials, including but not limited to paint, varnish, composition board, and plastics possess toxic compounds.

WARNING!

CAUTION!

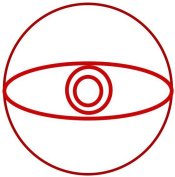

- **Always use the provided safety glasses when looking at the laser.**
- **Never aim any laser towards an aircraft or vehicle that is in motion.**

Laser cutting and engraving systems can present a significant fire hazard due to the extremely high temperatures generated by the laser beam. While the objective of most cutting and engraving operations is to vaporize material without burning, most materials capable of being cut or engraved are inherently combustible and can ignite. Usually this is a small flame of burning material issuing from the cut zone which self-extinguishes due to the air assist or depowering of the beam. However, it is possible for the flame to propagate and set fire to the machine and its surroundings.

CAUTION!



Always keep a properly maintained and inspected 5lbs. or larger fire extinguisher on hand. Full Spectrum Laser recommends a Halogen or multipurpose dry chemical fire extinguisher. Halogen extinguishers are more expensive than a dry chemical, but offer certain advantages should you ever need to use an extinguisher. The Halogen extinguishers are expensive but easy clean, while the dry chemical extinguisher discharges a sticky, corrosive powder that is very difficult to clean up.

Warning! Stacking materials can lead to increased risk of flame propagation or work piece ignition. Always keep the area around the machine clean and free of clutter.

Never store any flammable materials near the device.

Never operate your machine unattended. There is a significant risk of fire if set improperly, or if a mechanical or electrical failure occurs while operating.

Fiber Galvo Materials

Below are a list of materials usable with your Galvo.

Warning!! Using any material not listed below may void your warranty and may pose a fire risk!

Material	Raster	Vector
Aluminum	✓	✓
Nickel	✓	✓
Copper	✓	✓
Titanium	✓	✓
Leather	✓	✓
Rubber	✓	✓
Stone	✓	✓

Note: The Fiber Galvo is capable of cutting all these materials but specializes on engraving on metals.

Electrical Safety

The power supply is capable of releasing a current up to 45 mA. This power is sent to the discharge terminals on the laser tube itself. In order to prevent access to bare wiring your laser shipped in a protected box. Please notify Full Spectrum Laser support and immediately cease operations if the covers ever slip and expose bare wire.

Note: When performing any replacement procedures, make sure the machine is off for at least an hour.

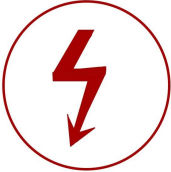

CAUTION!

- **Do not open any of the machine's access panels while the unit is plugged in.** Opening a panel may expose the operator to the unit's power box, which is potentially lethal.

- **Never make or break any electrical connections to the system while the unit is turned on.**

- **Never access any electrical areas with hands or tools unless the unit is disconnected from the power for at least one hour.**

- **Never replace the installed 20 amp fuse with one of a higher rating.** This will void your warranty and the electronics will not be adequately protected from surges or short circuits.

- **POWER ON/OFF is controlled by the switch at the back of the machine.** The machine is on when the (-) side is pressed and off when the "o" side is.

- **In case of a blown fuse always contact Technical Support before replacing anything.**

The standard for laser safety is the American Standard for the Safe Use of Lasers, Z136.12000. Developed by the American National Standards Institute (ANSI) it is the basis for many federal regulations and Occupational Safety and Health Administration (OSHA) guidelines for laser and laser system manufacturers. It contains detailed information concerning the proper installation and use of laser systems. While the ANSI standard is not a law, its recommendations, including warning signage, training, and the designation of a laser safety officer, may be mandatory under local regulations. It is the operator's responsibility to ensure that the installation and operation of the Full Spectrum Desktop Laser System are performed following applicable laws. Copies of ANSI Standard Z136.12000 are available from: LASER INSTITUTE OF AMERICA 12424 RESEARCH PARKWAY, SUITE 125 ORLANDO, FL 32826 (407) 3801553.

Section II. Connectivity

Ethernet Connection

The Fiber Galvo software is browser-based, meaning no download is required. RetinaEngrave v3.0 (RE3) is locally hosted on the machine's internal computer so it will function even without an internet connection. Using any computer, only an internet browser (such as Google Chrome) is needed to access RE3. The easiest method is to connect the Ethernet Cable that came with your Galvo.

Connect Via Router (Recommended):

Connecting the Galvo to the router is the most reliable way to establish a link to RE3.

1. The Galvo comes with an ethernet cable(see Fig. 18).

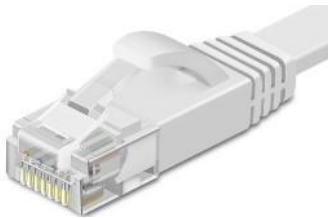

Fig. 18

2. Connect the cable to the ethernet ports on both devices(see Fig. 19).

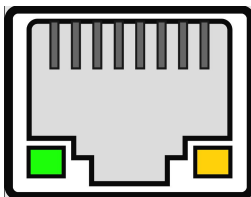

Fig. 19

Note: Ethernet port looks the same on all devices

Connect Directly to Computer:

Connecting the Fiber Galvo and the computer should only be done if the previous two options are not possible. The Galvo can connect to the computer via ethernet cable.

Note: The location of the ethernet port varies on computer models. Some computer may not have an ethernet connection and may need an ethernet adapter.

Connect to Wi-Fi:

1. Your machine should come with a device called a dongle attached to the usb port. This device enables your machine to connect to the wifi. Make sure that it is there and connected.

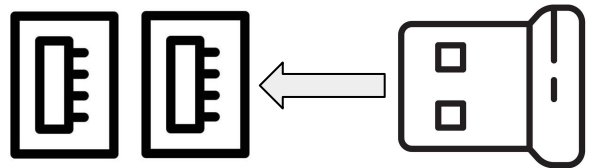

Fig. 20

2. Select the Network button on the top right of the touch screen.

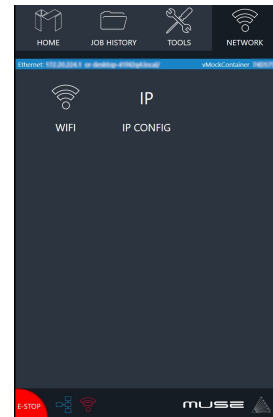

Fig. 21

3. Select wifi and look for your network. Select it and enter password

Connect to the Software

RetinaEngrave v3.0 is a combination of a print driver and control software that communicates with, downloads jobs to, and controls the laser system. There is no download required for RetinaEngrave v3.0. With a local connection (achievable with Wi-Fi or the included Ethernet cable) your Muse Galvo will link with the software's IP address

1. **Turn On Muse Galvo:** Allow 30 seconds or so for the machine and touch screen to boot up.
2. **Locate the IP Address in the blue line under the Home icon.** Alternatively, you can find the IP Address of the machine by tapping Tools -> About. The address will be listed there. This IP Address is of the network you connected the machine to. Wireless and Wired connections will have different IP Addresses.

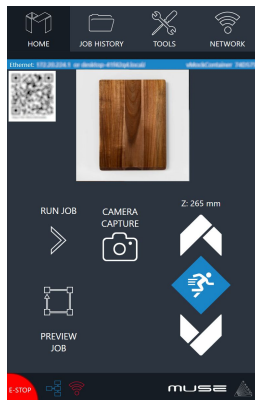

Fig. 9

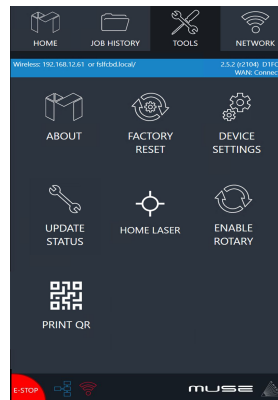

Fig. 10

3. **Type IP Into Browser**(Google Chrome is preferred). This will link you to the RetinaEngrave v3.0 (RE3) interface. You now have full access to the software. There is no need to install or download anything. You must, however, keep a local connection, either through Wi-Fi or the Ethernet cable.

Using QR Code:

Another method is to use the QR code which is visible in the Home and About sections.

1. Take a picture of the QR code using a QR reader.
2. A link will appear that can be selected.



Fig. 11

Section III. Touchscreen Interface

The touchscreen that comes on your Muse allows you to control the basic functions of your laser without needing a computer. Jobs are accessible through the touchscreen once loaded in from the RE3 interface.

A rotary function comes on your machine, which can be engaged from the touchscreen itself or RE3. Before activation the rotary mode, make sure your optional Rotary attachment is connected properly. Once enabled the screen will change to mention the Z-axis on the jog controls.

Home

The Home screen contains the devices IP address, the QR Code for RE3, the video feed from the camera, and controls for the laser head.

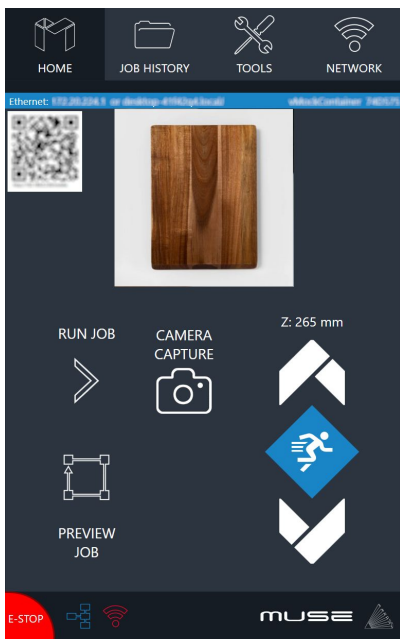

Fig.21

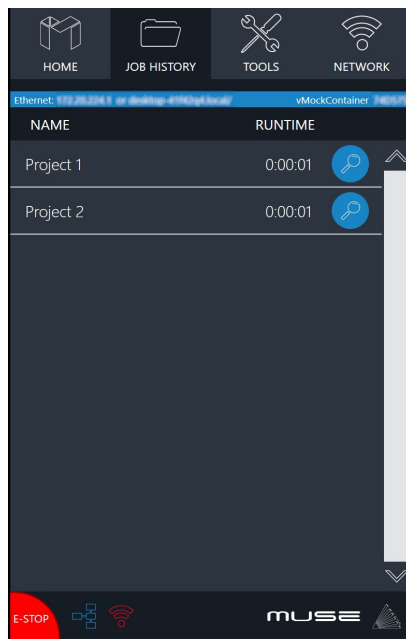

Fig. 22

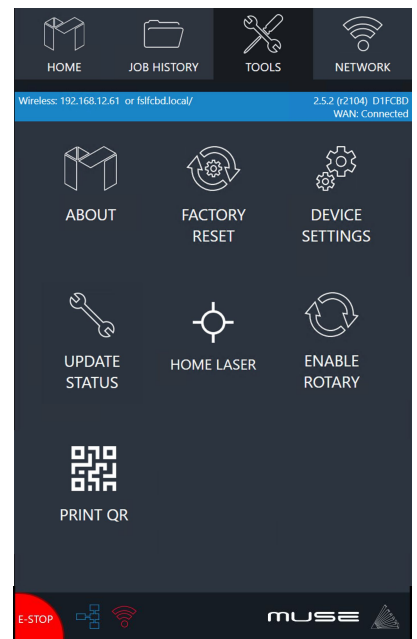

Fig. 23

Job History

The Job History icon allows the user to browse previous jobs. Clicking on the File allows the user to view and re-run previous job details. No Wi-Fi connection is needed to run jobs saved here.

Tools

The tools icon allows the user to check and adjust the machine settings. Here the user can enable rotary attachments, home the laser, and get information about the machine.

Tools ⇨ Update Status

The user can use the Update Status icon to check the Network Connection Status, Software updates, and connection history. (See Fig. 23).

Network ⇨ Wi-Fi

Allows the user to connect to the Wi-Fi.

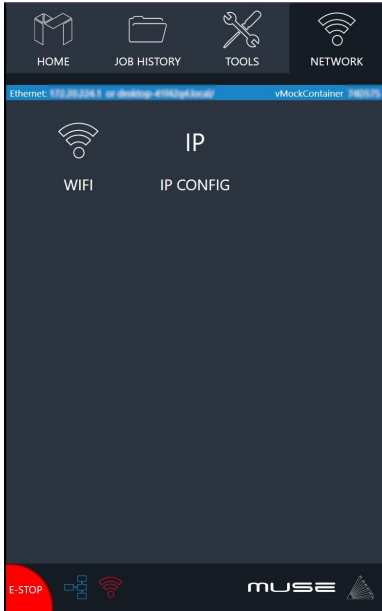

Fig. 24

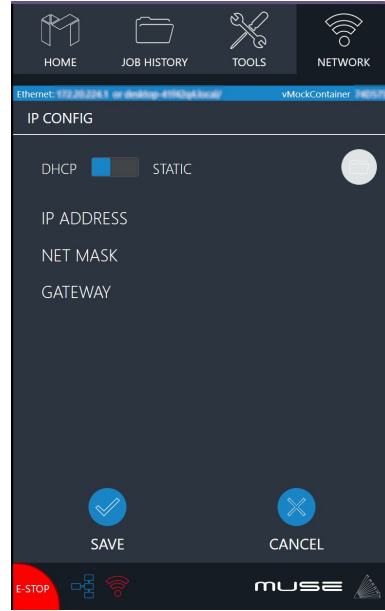

Fig. 25

Network ⇨ IP Configuration

Allows the user to set IP Address and DNS Server manually.

Most of the things mentioned in this section can also be done from your phone using the mobile or web browser version on RE3.

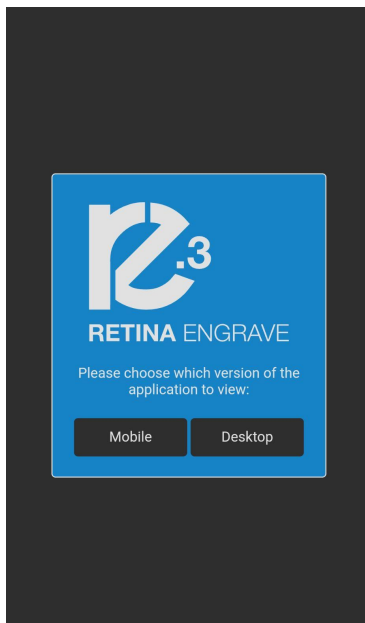

Fig. 26



Fig. 27

Focusing

Focusing must be done each time a new material is selected or when restarting your machine.

Auto-focus:

1. Your Galvo came with a black anodized aluminum card that can be placed on your desired material under the laser head.

Note: Make sure the QR code is visible on the camera during focusing. If the QR Code is not within the camera's via during focusing, then the focusing must be done again.

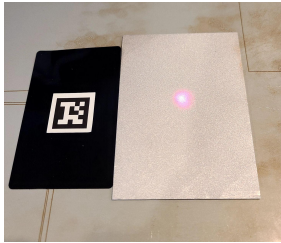

Fig. 15

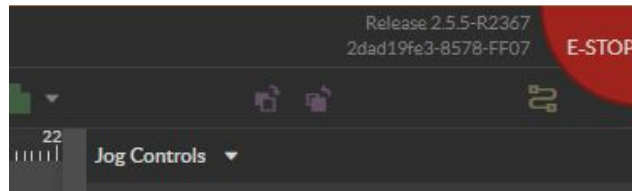

Fig. 16

2. On Retina go to the top right section of your browser and locate the jog Controls.(See Fig.16)
3. Select the Jog Control arrow to open menu and select the **Z** autofocus button.(See Fig.17)

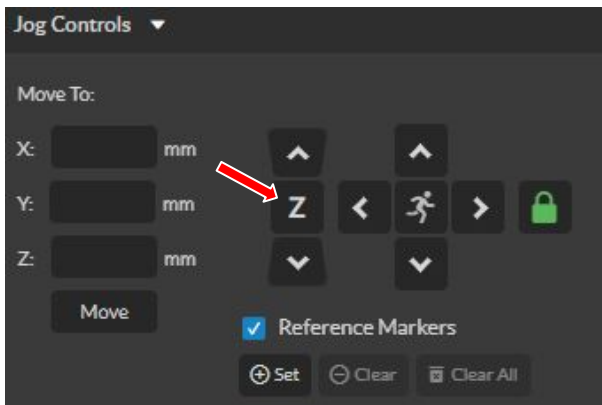

Fig. 17

4. The lens will move into the appropriate position for the selected material.

Manual Focus:

If one loses the QR card or simply chose not to use it, then they will have to focus the laser head manually. The appreciate engraving distance is determined by the lenses focal length. Below is a chart of our lenses and their required distance.

Lens Focal Length	Distance from Material
163mm	203mm
254mm	294mm
330mm	370mm
420mm	460mm

Laser Focus Test

Once your machine is in the appropriate height we need to run the focus test.

1. Place a piece of paper or plastic above the selected material.

2. Select the laser focus icon.(See Fig.18)

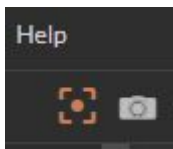

Fig.18

3. Make sure the appropriate lens size is selected before hitting the generate test pattern option.

WARNING!! This will fire the laser!
Make sure you are at least 12 inches away from the laser if you are not wearing safety glasses.

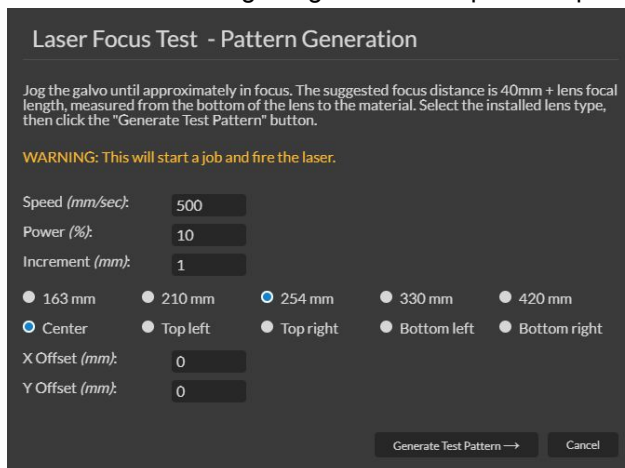

Fig. 19

8. The laser will produce a grid of marks from A through H vertically and numbers 1-6 horizontally.(See Fig.20)

Note: The marking in the focus test are in millimeters and may require some means of magnification.

9. Chose the 2 most visibly similar blocks and input them into the Pattern Selection then select "Focus Job Result", and then done.

Example: In this picture 3F and 4D are visibly similar so they can be chosen.



Fig. 20

Note: If focus test does not produce the grid then it may need to be re-focused or needs a different material for the test.

For more help, please check our video on focusing your laser and camera calibration @ https://www.youtube.com/watch?v=SZFqi_WLHBI .

Section IV. Operations

This section will guide you through using your Fiber Galvo. To get started, it is important to understand the meanings of “Vector Cutting” and “Raster Engraving” and their associated file types.



VECTOR	RASTER
Project Examples	
Signs, Logos, Parts, Gears	Image Engraving, Surface Marking
File Types	
PDF, SVG, DXF, AI	JPEG, PNG, BMP, TIF
Preferred File Types	
PDF	JPEG
File Composition	
Geometrics Formulas	Pixels

General Functions

Vector Cutting

The most common feature when cutting with a laser engraver or cutter. When vector cutting, the laser follows the “vector lines” embedding in the vector image to cut out the design. The laser starts at a designated location and follows the vector lines until the shape is cut out. This process is highly accurate and requires no resolution adjustments because of the properties of a vector image. RE3 receives information from the print stream and interprets it as a series of paths for the laser head to follow. For the print stream to have that information, the file being printed must be a vector. These images are created using mathematical equations, making them more flexible than rastered images. PDF's, company logos, and branded graphics work great as vector files and are easy to resize without losing resolution.

Engraving

Engraving is the process by which designs are etched into something. This can range from surface marking to material removal depending on settings used. This is also referred to as the 'Raster' or 'Rasterizing' process. As lasers can only print in two colours- on or off, any image imported will read as black or white. Black would be 'on', telling the laser to fire for that pixel. This changes for every pixel in the image so resizing is very important as raster files can become grainy or distorted. It's important to resize the image properly for your engraving needs before importing into RE3. Common raster file types are PNG, JPG/JPEG, BMP and TIF though PNG is generally preferred as the smallest but less compressed format..

Direct Printing PDF Files

The easiest way to import any file type to RetinaEngrave v3.0 is to “drag ‘n drop” it directly into the workspace window or use the File> Import File. Another method would be to “Print” the PDF file which can send the data directly from your chosen design software into RetinaEngrave 3.0. A PDF file type is the preferred method as this can hold both vector and raster data. Be aware that you may need to install the print drivers on our website. Link and instructions can be found here: <https://laser101.fslaser.com/retinaengrave> .

Designing in RetinaEngrave v3.0

RE3 has a robust set of design tools, allowing users to design in the software without needing outside design software. Third party design software, however, is still an option for RetinaEngrave v3.0 users. Just about any design software will work (You can choose the software you are most comfortable with, as long as you can convert files to PDF (which most can). You can also “direct print” to the software. Each operating system does this in a slightly different way, so check the instructions for your particular program.

Project Workflow: From Concept to Design

RetinaEngrave v3.0 create a simple, easy to learn set of operations. Your Fiber Galvo will achieve amazing results using this Project Workflow List. For the “best practice” for any project, follow the step-by-step instructions from start to finish.

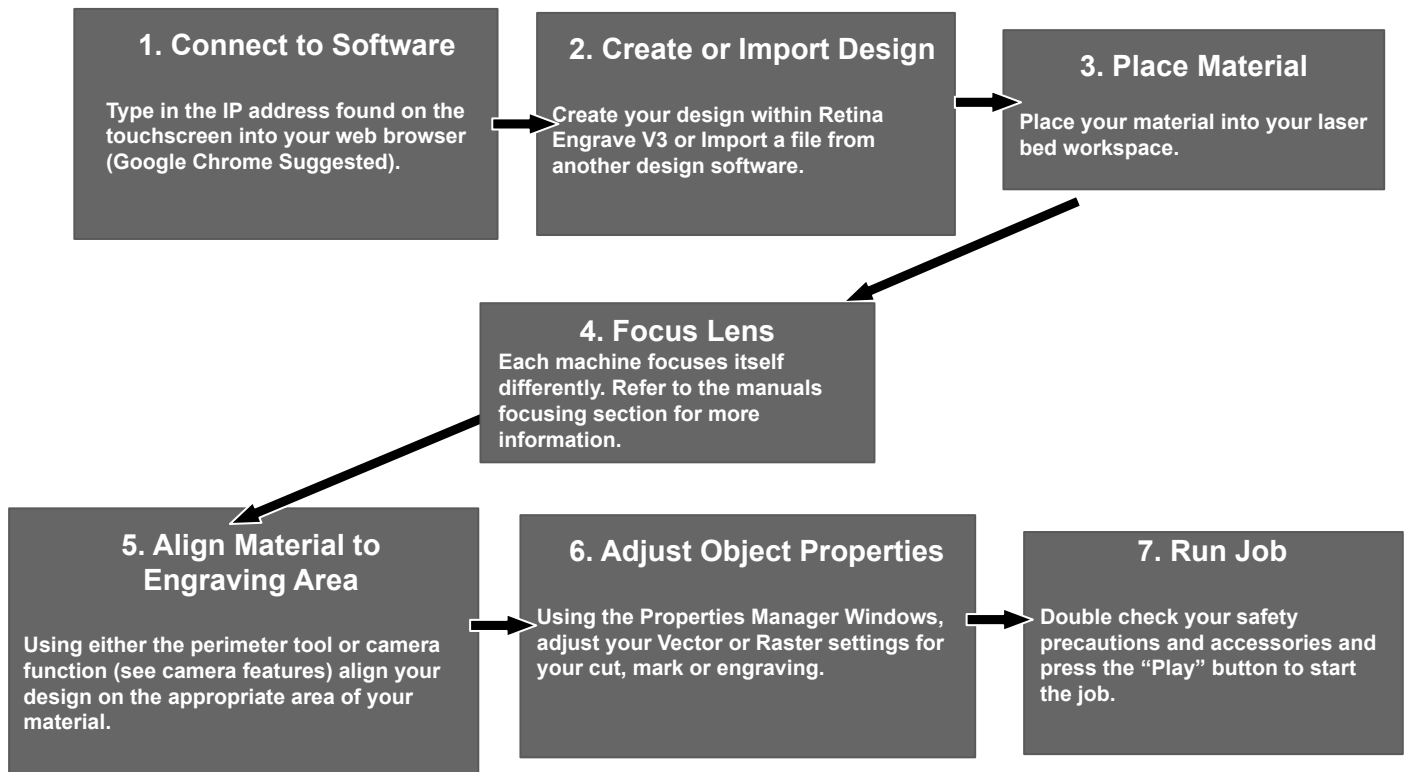

1. Create Design

Projects are created in design software and then imported to RetinaEngrave 3.0. A PDF file is mainly used for both raster and vector data due to its ease of conversion. For engraving, a JPEG file is best due to its bitmap files. It is important to know if you intend to do a vector cut or an engraving and choose the most appropriate file type. This will greatly aid the user to design in RE3 without needing outside design software. If the user decides to use a third party software, choose one you are most comfortable with, as most can convert the image to PDF. You can also “direct print” to the software. Each operating system does this in a slightly different way, so check the instructions for your particular computer.

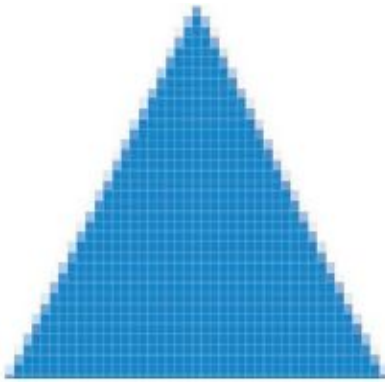

Raster Image (bitmap)

Pixel based image.

Examples: JPEG, PNG

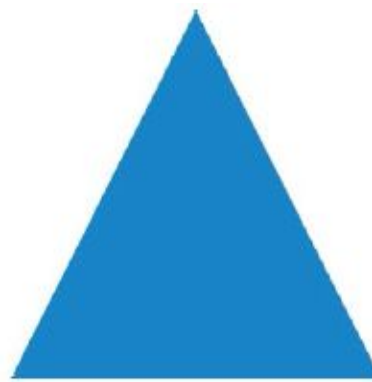

Vector Image (bitmap)

Vector File Geometric based image.

Example: SVG, AI, PDF

2. Connect to Software RetinaEngrave v3.0

Refer to Section II: Assembly & Connectivity.

3. Import Design

Import your designs by selecting the “Open File” icon, or by dragging and dropping your file into the workspace. This software detects a wide variety of file types.

4. Place Material

Place your material into the laser bed workspace. The material can be placed anywhere in the work area. Once the material is placed, close the lid. Your material can range from wood, acrylic, cardboard, fabric, and steel.

Note: It is the user’s responsibility to know the components of material used and its limitations (thickness, chemical residues, etc.). Check with the material manufacturer, or MSDSONline.com, if there are any questions to its usage. We recommend using a Materials Log to keep track of the different materials you use.

5. Focus Lens

Your Galvo should be re-focused after changing a material.

****Refer to Focusing Section****

6. Align Material to Engraving Area

The material should be aligned to ensure the design is within the workspace and positioned straight. This can be done with a simple vision check while “jogging the perimeter”. By using the directional arrows on the touchscreen or the arrow keys on your computer, move the laser dot to the top left corner of your material. When placing an engraving image, leave at least ½” inch of space on the left and right side of the workspace. Once the material looks aligned, click the “Run Perimeter” button. The laser head will automatically outline the material with the red beam diode, adjust as needed.

Note: Laser will continue to outline the material until manually stopped by re-selecting “Run Perimeter”. Also note that the location of the images will vary depending on the positioning options selected. In absolute position the laser will go wherever you put the image in the workspace, while in relative it will always try to start in the upper left corner.

7. Adjust Object Properties

It is again important to know if you want to engrave, cut, or both. Once the file is imported, you will have access to the Properties Tab. Click this tab and select the parameters for your cuts and/or engravings. For details on setting these parameters, see the following section.

8. Run Job

Selecting the “Play” button begins the laser process. Therefore, double check your safety protocol and that your system accessories are connected properly. Be sure to monitor the job while the laser is firing. If a problem occurs during the process, stop the laser.

Section V. RetinaEngrave v3.0 Software

Starting with RE3

Our machines are set apart from our competitors with our custom laser engraving software, known as RetinaEngrave v.3 or simply RE3.

Using your new machine for the first time can seem intimidating but we've worked to make this guide as clear as possible regarding our software. In the previous section we mentioned having an idea of the design and materials for your project. Once you have that prepared you're ready to start using RE3.

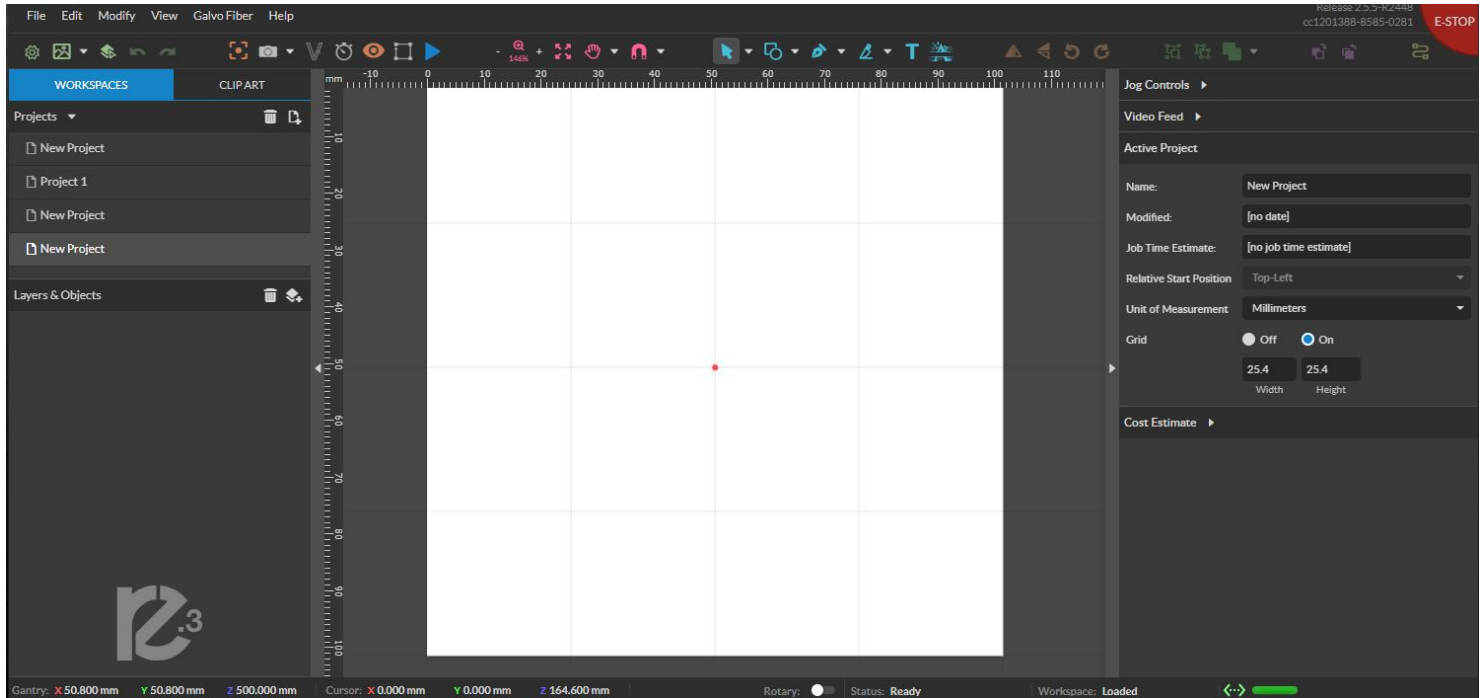

RetinaEngrave V.3 will look like this when fully loaded on the browser.

Note: The device must be on and fully booted to access RE3. If the machine is off RE3 will inform you that the device has been disconnected.

1. Select the file you wish to engrave via your editing software or an image saved on your computer.
 - a. It can be placed into RE3 using two methods:
 - It can be “dragged” into your RE3 workspace using your mouse.
 - It can be placed using the photo icon.

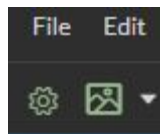

- b. Modify the image in RE3 to be the proper size, laser settings, and file type (raster or vector), as well as any other laser properties that are specific to that engraving

2. Prepare the material you wish to engrave. If the material you are working with is new to you or untested, make sure you have enough material to test with to ensure your settings are correct before marking the final part/design.

3. Focus the laser to the material if you have not done so.

a. Method 1: QR Tag (Preferred)

Refer to Focusing Section

b. Method 2: Use Depth map

i. When no autofocus mark or april tag is detected, the laser will focus based off the depth map from the 3D camera

ii. The location of your design in the workspace will determine the focus position.

NOTE: The focus distance number set in the RE3 interface is machine relative. It signifies a distance away relative to home, not a distance away from the part.

4. Align your design with your material

a. This can be done by using the eye icon or the perimeter icon to preview the area where the laser will engrave.



Note: The Eye icon will procedure a line that will run up and down the work area, while the perimeter icon will form a square image of the work area.

****Using the camera capture option that can help for better alignment of your design. One should still make sure to check the engraving perimeter before running your job.****

b. Adjust the design or material to ensure your design is engraved in desired area.

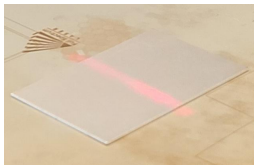

Note: Here the image was larger than the selected material, therefore the design was reduced in size to fit perfectly.

c. Ensure the material has enough weight so as to not move while engraving.

Note: A jig, fixture, putty, or tape can be to use to set objects in the same position for repetition.

5. Once the picture is aligned with the material and checked via preview, you are ready to run your job.

d. Run the laser using the play button.

**WARNING!! PUT ON SAFETY GLASSES BEFORE STARTING!
LASER CAN CAUSE EYE DAMAGE!**

e. Once the marking is complete, do not move the part until you are sure that it has the desired look, as realigning becomes significantly difficult.

f. Wipe your part clean of any dust/residue resulting from the engraving process

Congratulations!! You have made your first engraving on RE3. It's an exciting process to engrave material to your liking. Sometimes a little trial and error is needed to see what designs go well in what ways. The following pages will provide more information on how to use RE3 for more detailed and precise engravings.

For a more detailed and in-depth look into RE3, please use the RE3 Guide, which can be found at <https://fslaser.com/resources/> .



Fig. 54

This camera uses multiple apertures simultaneously to create a 3D map of your workspace to get the most accurate data for your laser projects. Saving time and money on materials with the 3D camera system is a major benefit. Also the 3D camera allows you to do cool things like our trace feature in RE3. To learn more take a look at our software section. The camera is mounted on the rail of the 3D to ensure every inch of your workspace is captured.

3D Camera Calibration

1. Lay out about 1 to 2 sheets of letter sized paper centered under the red dot. Ensure these sheets are flat and smooth to produce the best calibration.
2. Make sure your Galvo is focused if you have not already done so.
3. Enter the setup page for your machine via IP/setup
4. Then go to the “Laser Tools Tab”
5. Select “Run Lens Calibration”.



WARNING! Wear Safety Goggles! LASER WILL FIRE! Do not handle or turn off the laser during this process. The laser will produce a grid of dots.

6. Once calibrating, it will give a result of “Passed”.
7. To check your results go to the section directly below titled “**Verify Camera Calibration**” to ensure the lens can be use.

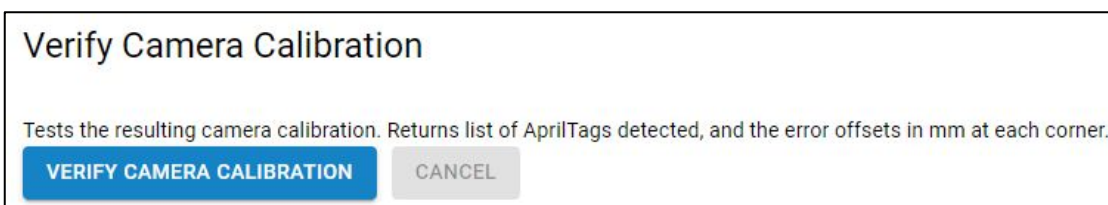

Section IV. Lens Calibration

NOTE: THE MACHINE IS SHIPPED PRE-CALIBRATED.
DO NOT CALIBRATE UNLESS INSTRUCTED TO DO SO.

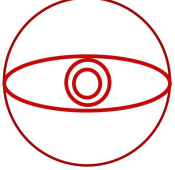
 <p>WARNING!</p>	Make sure to avoid direct sunlight, glare, and/or bright lighting while operating the machine as they can impair the sensors.
	Remember to always wear protective eyewear while running the laser.

Warning!! Calibration cannot be done in Rotary Mode.

Calibration should be performed if:

1. The camera is changed or manipulated.
2. The lenses are removed, replaced, or changed.
3. Focusing accuracy has degraded and the laser is not marking.

Lens Removal and Replacement:

If you wish to change the lens, the machine must be calibrated again. Ensure lenses are probably stored with appropriate lens caps and are not cross threaded when mounting.

1. Ensure laser head is in a reachable position to remove lens.
2. Remove any objects or work pieces from underneath the lens work area.
3. Turn off.
4. Install the lens cap onto your lens.

Lens Size(mm)	Working Area Approx. (mm)
163	110X110
210	140X140
254	175X175
330	220X220
420	300X300

Fig. 12

- a. Carefully twist counter clockwise to loosen the lens.
Note: Try to avoid damaging the camera or camera shutter located on the side of the scanhead.

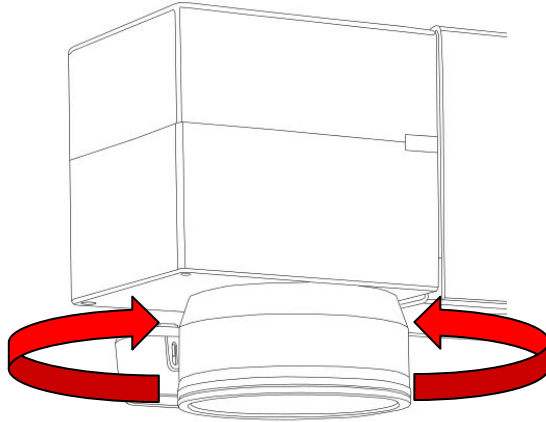

Fig. 13

Avoid touching the glass surface of the lens to prevent scratches.

- b. Lens collar may loosen along the lens, if that occurs remove both together and separate once dismantled.
c. Replace the collar to the scanhead before inserting a new lens.

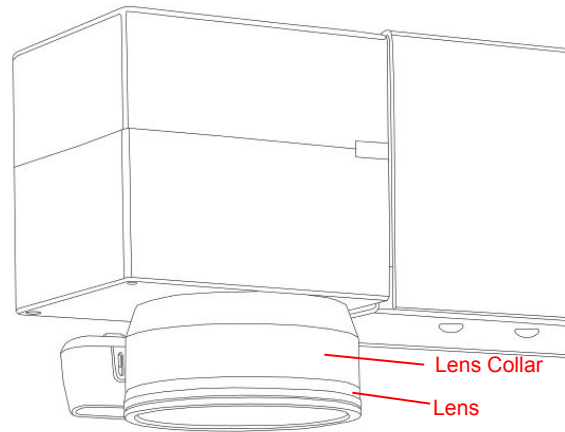

Fig. 14

- d. Remove top and bottom protective lens caps and screw new lens into collar on scan head
DO NOT OVERTIGHTEN LENS!
e. Wipe down the glass surfaces with optical lens wipes if you notice smudges, fingerprints or other contaminants.

NOTE: Do not use microfiber cloths, shirts, rags or other materials as they can cause scratches.

Recalibration Process

1. Machine should be on and on the home screen.
2. Click the tools icon, then select home laser to return it to home position.
3. Access the setup page for your machine via IP/setup
4. Then go to the "Laser Tools Tab" and scroll down until you find "Run Lens Calibration" option.
5. Once the calibration is running your lens will be ready for use.

Since the lens has been changed, we need to make sure the markings are adjusted to the new lens.

Mark Adjustment

1. Run the mark adjustment to verify that the calibration process was successful.
2. Set a speed of 100mm/sec and input the lens size you are using.
3. Place a piece of test material under the laser for marking.

Note: Preview the square before proceeding to ensure only test material is marked.

4. Select "Mark Square".
5. Measure the marked square and input the measurements into the boxes.

Note: The top left corner of the square is cut off intentionally.

6. Select "Save Mark Adjustment"

Mark Adjustment

Enter the size of the square to mark and click the "Mark Square" button.

The recommended sizes are:

50 for 100mm lens, 100 for 160mm lens, 110 for 163mm lens, 145 for 254mm lens, 225 for 330mm lens, and 288 for 420mm lens.

Speed (mm/sec):

300



Power (%):

100



Size (mm):

145



Preview Square

CANCEL

Mark Square 

Preview Adjustment

1. Mark a new, properly adjusted square
2. Without moving the part you just engraved, press "Preview Square"
3. Use the adjustment buttons so that the red dot trace perfectly overlaps the marked square.
4. Select "Save Preview Adjustment."

Preview Adjustment

Click the "Preview Square" button then use the "X/Y Scale/Offset Up/Down" buttons to line up the red laser preview with the previous square mark. Click the "Save Preview Adjustment" button to save the results. Unsaved changes will persist until power cycle or the "Reset" button is clicked.

Use the buttons below to adjust the width, height, or horizontal/vertical offset so that the red laser preview matches the previous square mark

PREVIEW SQUARE CANCEL

← → ↕ ↑

↖ ← ↘ ↓

SAVE RESET

For more help, please check our video on focusing your laser and camera calibration @ https://www.youtube.com/watch?v=SZFqi_WLHBI .

Camera Shutter Replacement

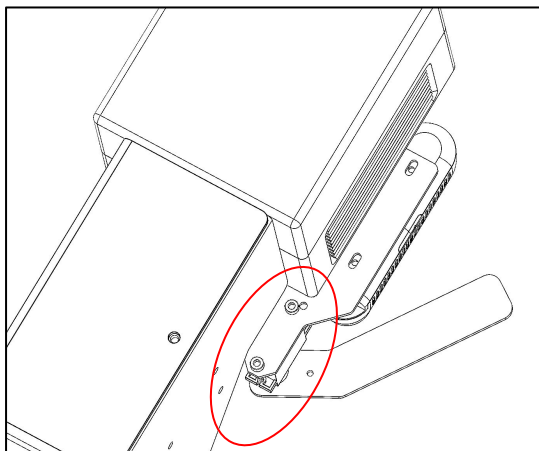

Fig. 28

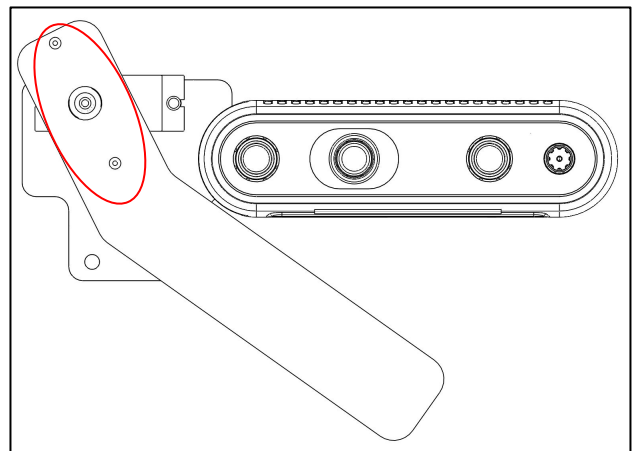

Fig. 29

1. **Power off and unplug your unit.** Wait at least 1 hour for capacitors to discharge.
2. The Shutter has 4 M4 screws. The first two hold the motor in place and the others attach the shutter to the motor. (See above).

3. The motor is connected to a tri-colored wire. Disconnect the wire before continuing.

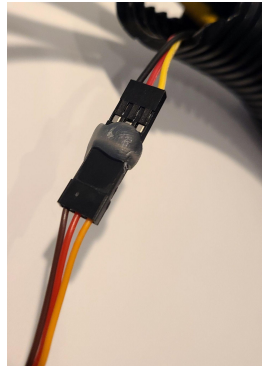

Fig. 30

Note: Some wires may be covered in hot-melt adhesive to prevent separation.

4. Remove the screws holding the motor in place (see Fig. 28).

5. Remove and replace the motor.

6. Replace the screw and reconnect the wire.

Note: It is recommended to secure the wires some way to prevent separation.

7. Turn on the machine and once again go to the set up page. Then go to the “Laser Tools Tab”.

8. There will be a section for Camera Shutter Position. Set the open value to 1.7 and the closed value to 1.3.

Camera Shutter Position

The opened and closed position values indicate the correct opened and closed position of the camera shutter. Adjust the values and use the test buttons to verify. When finished, save the values.

Opened (0.01-2.55):
1.9

Closed (0.01-2.55):
1.6

TEST SHUTTER OPEN TEST SHUTTER CLOSED SAVE VALUES

9. Test both values and adjust the shutter accordingly(see Fig. 31).

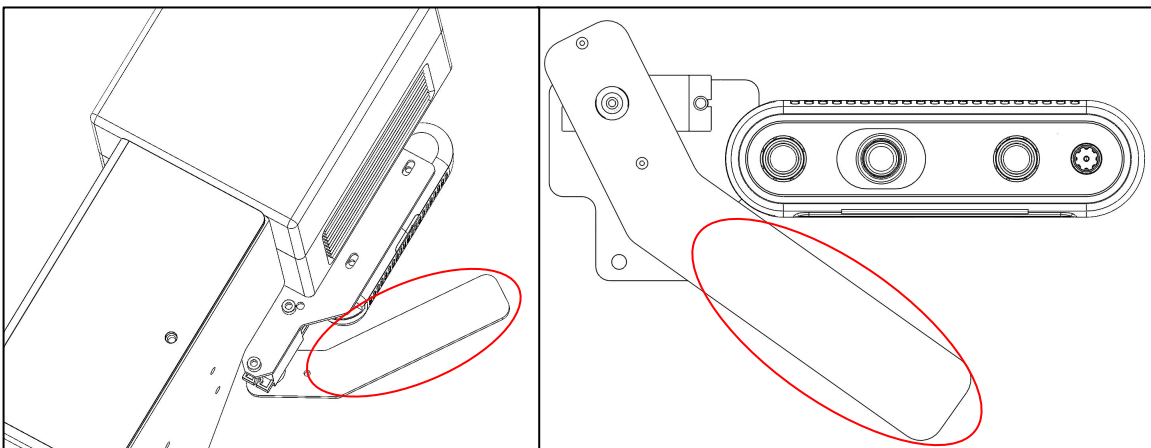

Fig. 31

Troubleshooting & Applications

Troubleshooting

A large amount of problems customers face centers around laser focusing. These lasers must be within its focus range to function properly. Being outside of focus will yield no mark at all. Before calling tech support, please verify that you are in focus using the black card provided. (Refer to Focusing section.)

Issue	Possible Solution
Laser Won't Mark	<ul style="list-style-type: none">• Make sure your machine is focused. If the machine is off in height by a few millimeters it will not engrave. Make sure to refocus your laser head after changing to a new material.• Verify that the material used is receptive to 1064 nm wavelengths (1064 nm and 1080 nm are the main wavelengths used in fiber laser engravers.)
I can't get the marks I want	<ul style="list-style-type: none">• Make sure the material is usable. Some materials are not meant to be cut with the Galvo.• Try some of the setting ideas mentioned in the marking applications. We have a raster and vector materials tests on our website to help you find the types of engraving you want. Visit https://fslaser.com/material-test/ for the files.
My engraving lacks depth	<ul style="list-style-type: none">• May need to increase the power and/or lower the speed.• Multiple passes can add more depth.• A smaller lens can be used to engrave in more detail.• The laser may engrave even if it's not fully focused. Make sure to perform the laser focus test each time you change to a new material.
I'm having trouble focusing my laser.	<ul style="list-style-type: none">• If the QR tag is used then one should make sure that the QR tag is visible in the camera throughout the process. If the QR tag gets cut off or leaves the screen, then the machine will not focus.• One can always try the manual focus. <i>*Refer to the Focusing section of the guide*</i>
The Mark Adjustment square looks wobbly.	<ul style="list-style-type: none">• If the camera calibration was done on a wrinkled, bumpy, or slanted surface, then the calibration will be off.• Make sure the camera is calibrated on a flat, smooth, and leveled surface.
The marking are not coming out even.	<ul style="list-style-type: none">• If the material your engraving on is not flat or leveled then the material will engrave unevenly. We suggest getting something to make the engraving surface leveled beforehand.

Marking Applications

One should keep in mind that every material will react differently based on the settings used. Materials can have different grades or alloys will affect the engraving process. It is up to the user to determine their application and the best process for their needs. Many factors are involved when using the Galvo laser, such as speed, power, frequency, lens size, the power source (20W or 50W), focusing and material grade. This is a general list to give an idea of how one can go about getting the engraving desired.

Marking Types	Methods Used
Deeper Engraving on steel	<ul style="list-style-type: none"> • High Power, Medium Speed, 25-50 passes • Multiple passes can be programed. • Low khz
Surface Marking	<ul style="list-style-type: none"> • 20W- High power & Low Speed • 50W- High power & Low Speed • 4-8mm in/out of focus
Thin Cuts	<ul style="list-style-type: none"> • High Power & Medium Speed • Use wobble amplitude .1 and spacing .05 • Low khz
Marking black acrylic (Bleaching the surface)	<ul style="list-style-type: none"> • Low Power, Low Speed & Low DPI
Annealing	<ul style="list-style-type: none"> • High Power, Low Speed & unfocused by 4-8mm • Multiple passes • Mid range khz

Examples

With your new laser engraver, the sky's the limit. All you need to worry about is your own imagination. In order to help spark it we picked some projects others made to help show you the potential of your Fiber Galvo.

Painted Metal

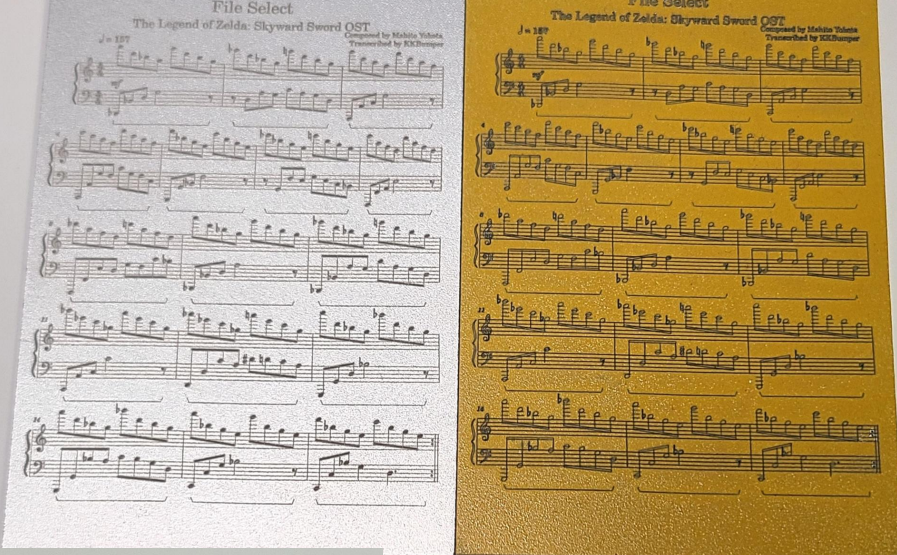

Purple Anodized Card



Tumbler



Tin



Glass



Free Projects & Extra-Help

We hope that this manual helped make your Fiber Galvo experience more enjoyable. We know that sometimes getting started is hard. That's why we offer free projects and other helpful tips and tricks on our website. If you wish to browse the free project list or to get more information just visit us at <https://fslaser.com/laser-101/>.

Below we'll show some samples of plans you can get from our website. We hope that these projects will help kickstart your creative adventure.



Warranty

Full Spectrum Laser will replace or repair any defective parts free of charge within the first 30 days. Ground shipping is free with overnight shipping available at extra charge.

Full Spectrum Laser will replace or repair any defective part within the warranty period free of charge but shipping charges are the responsibility of the customer. Warranty includes parts and labor only. Shipping of defective and replacement components is excluded.

The customer may arrange their own shipping. Parts can be dropped off at our warehouse free of charge.

All defective parts must be returned to Full Spectrum Laser for evaluation before replacements are issued, unless otherwise authorized. The warranty is valid for normal use only and excludes uses not stated in manual. Parts damaged by fires are considered user error if the machine is left unattended. Always stand next to the machine with a fire extinguisher and be ready to turn it off in case of an emergency. Never operate the machine unattended.

Products sold before 8/7/2012, had a 60-day base warranty on all items excluding shipping unless an extended warranty was purchased.

Our lasers have a 60-day full warranty and include a 1-year extended warranty. The 1-year extended warranty excludes shipping and consumable items. All electronic items (control cards, power supplies, motors) and most mechanical items are covered under the extended warranty unless damaged by abuse/fires. Consumables not covered include, but are not limited to, rubber parts (such as tubing, belts, plastic wheels, lenses, mirrors, other optics, and laser tubes).

The original purchaser may transfer the balance of the warranty to anyone free of charge provided we are notified in writing within 30 days. After 30 days, we will only provide warranty and tech support services to the original purchaser unless a warranty transfer fee.

Warranty will remain valid if product is sold. However, the buyer must request RMAs and repairs from the original purchaser unless a warranty transfer fee is paid.

NOTE: Full Spectrum Laser DOES NOT offer warranties or customer support for 3rd Party parts, including replacement laser tubes, as it may not be compatible with Full Spectrum Laser machines and can cause damage to your laser system.

Visit <https://fslaser.com/terms> for most current warranty postings.

Customer Support

If you have any questions about your machine don't hesitate to contact us. We have a large number of resources available to make your first laser experience user-friendly.

Technical Support



M-F 8AM-5PM PST
support@fslaser.com
702-802-3103

Sales



M-F 8AM-5PM PST
sales@fslaser.com
702-802-3101

Manuals



fslaser.com/resources/
User manuals, Quick-Start Guides
and other resources for your laser.

Financing



fslaser.com/financing/
Work with us or our providers to find
the perfect option for any budget.

More Options

Submit a ticket online
fsl3d.zendesk.com/hc/en-us

Videos
youtube.com/user/FullSpectrumLasers

Blog
fslaser.com/blog/

Free Projects
blog.fslaser.com/freelaserprojects

Retina Engrave 3.0
<https://fslaser.com/software/>

Reach out to Us

Headquarters
6216 S Sandhill Rd
Las Vegas, NV 89120

PHONE: (702) 802-3100
FAX: (702) 987-0150

Order Status | Shipping | Accounting
M-F 8AM-5PM PST

You can also sign in to check order status

Shipping email: shipping@fslaser.com

Accounting email: accounting@fslaser.com

READY TO UPGRADE ?

Have you gotten the most out of your desktop laser? have you hit the limits of your output quotas and want to see how the professionals do it? Step up to Professional Grade with P-Series and the Muse Titan by Full Spectrum Laser.

Our P-Series and Muse Titan take your production to the next level. Industrial grade components give you faster movement, better precision and increased laser power. All P-Series and Muse Titans come with our RetinaEngrave software, Motorized Z-stage, AutoFocus, Knife Edge and Honeycomb tables.

Do you have a more specific marking and or engraving application? Something to engrave the smallest of details? Look no further than the Muse Fiber Galvo and the UV Galvo. These machines are designed to capture and engrave extreme details on metal and other special materials.

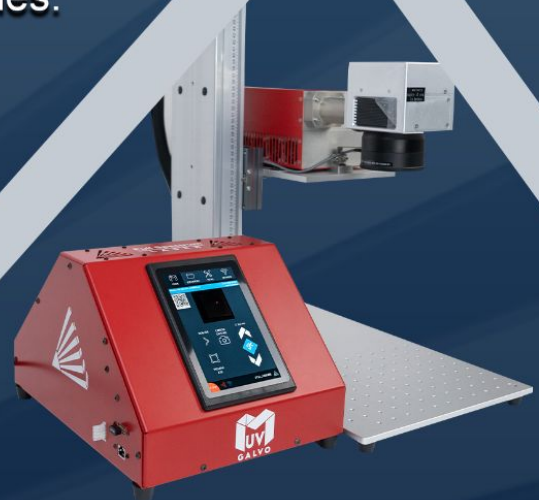

Full Spectrum
L A S E R

JOIN THE FULL SPECTRUM LASER COMMUNITY

FULL SPECTRUM LASER INVITES YOU TO JOIN OUR COMMUNITY OF HOBBY MAKERS AND PROFESSIONAL MANUFACTURERS THROUGH OUR SOCIAL MEDIA CHANNELS (FACEBOOK, INSTAGRAM, TWITTER, YOUTUBE) WE ALWAYS HAVE SOMETHING POSITIVE TO SAY ABOUT HOBBY MAKER CULTURE OR THE INDUSTRY WE WORK IN. YOU CAN FOLLOW US AS WE CROSS THE COUNTRY GOING TO CONVENTIONS AND MAKER EVENTS OR JUST CHECK OUT ALL THE AWESOME STUFF WE MAKE. BEST OF ALL, WE OFFER ALL THOSE DESIGNS FOR ALL THOSE PROJECTS WE MAKE WITH OUR LASER CUTTERS FOR FREE. JOIN OUR COMMUNITY AND SEE WHAT ALL THE EXCITEMENT IS ABOUT

- WWW.FACEBOOK.COM/FSLASER

- WWW.INSTAGRAM.COM/FULLSPECTRUMLASER

- WWW.TWITTER.COM/FULLSPECLASER

- WWW.YOUTUBE.COM/FULLSPECTRUMLASERS



Full Spectrum
L A S E R